

EDSYN^{INC}®

CL1080 LONER[®]

Temperature Controlled SOLDERING INSTRUMENT

- 120V, 60Hz, 70W, 5 Oz (142 gm)
- TEMP. RANGE: 400°F - 800°F (205°C - 427°C)
- TEMP. REGULATION: ±6°F (±3°C)
- TIP TO GROUND LEAKAGE: < 2MV
- TIP TO GROUND RESISTANCE: < 2 OHMS
- COMPLIES WITH DOD-STD-2000-1B, MIL-STD-2000A and ESD SPEC. DOD-STD 1868, DOD-HDBK-263

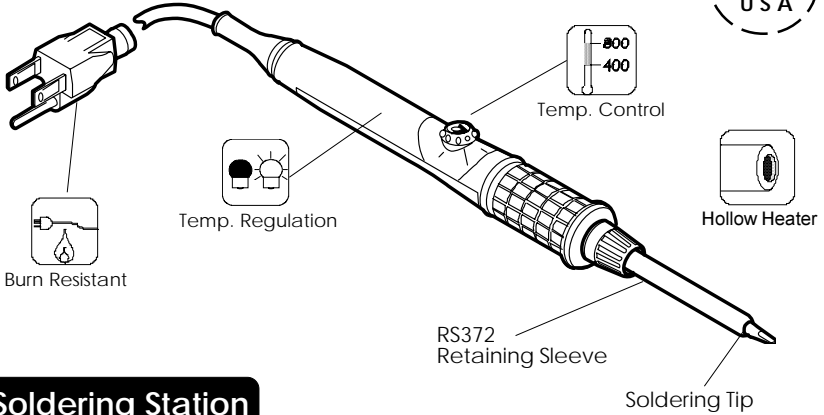

930 Soldering Station

includes CL1080 and IP329

WICK AND SOLDER SUPPLIES SOLD SEPARATELY

idle-rest
IP329
Tool Base

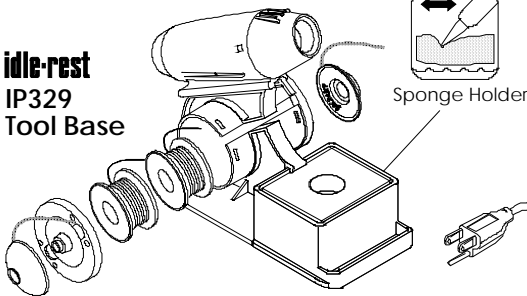

935 Soldering Station

includes CL1080, PD528 and PS536

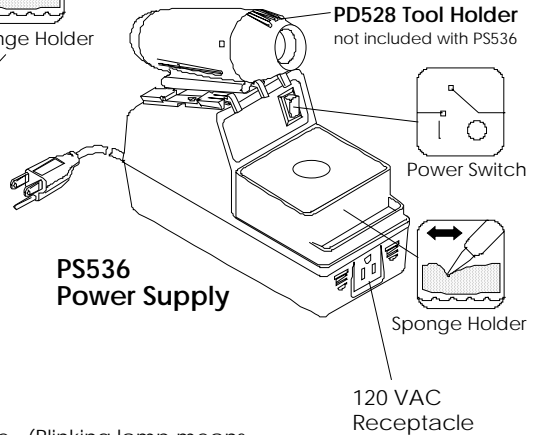

TIP CARE

1. Plug-in Tool. Set to desired temperature. (Blinking lamp means set temperature is reached.)
2. TIN the Tip (apply solder) before soldering.
3. Do not rub, bend or file Tip.
4. Always clean the Tip by wiping it against the saturated sponge, then re-tin.
5. ALWAYS RE-TIN THE TIP BEFORE AND AFTER USING.

CHANGING TIP

1. MAKE SURE YOUR TOOL IS COOL!
2. Turn **RS372** counter-clockwise to remove.
3. Remove old Soldering Tip.
4. Insert new Tip.
5. Install RS372. (should be "finger" tight only.)

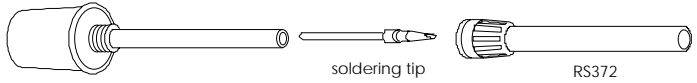

SOLDERING TIPS

Iron Plated for long life • Nickel and Chrome Plated for optimum heat transfer
CONTACT EDSYN FOR MORE SELECTIONS

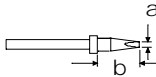

			a	b
	LT374	Standard Probe	.03 (0.8 mm)	.48 (12.2 mm)
	LT375	Standard Spade	.06 (1.5 mm)	.48 (12.2 mm)
	LT392	Extra-Long Needle Point	.02 (0.5 mm)	1.13 (28.8 mm)
	LT394	Extra-Long Spade	.07 (2.0 mm)	.93 (23.6 mm)
	LT446	SMD Probe	.03 (0.8 mm)	.48 (12.2 mm)
	LT337BC	Heavy Duty Terminal Spade	.10 (2.5 mm)	.74 (18.8 mm)
	LT223BC	Heavy Duty Fine Spade	.06 (1.5 mm)	1.21 (30.7 mm)
	LT222BC	Extra long Needle Point	.04 (1.0 mm)	1.21 (30.7 mm)
	LT153BH	Jumbo Spade	.20 (4.9 mm)	.93 (23.6 mm)
	LT155BH	Jumbo Angle Spade	.32 (8.3 mm)	.97 (21.1 mm)



Fine point tip for SMD soldering.

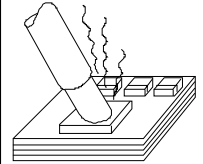

Large and heavy tip for heavy duty soldering.

SET-UP & REQUIRED ACCESSORIES FOR HEAVY DUTY AND JUMBO TIPS

Apply **AN112** or **AN122*** Anti-Seize Compound to Heater and area of Tip contact.

*AN122 Anti-Seize Compound comes in syringe dispenser.

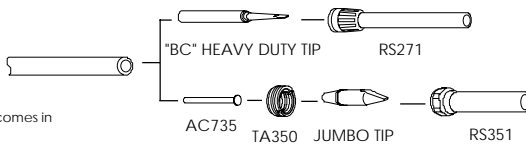

MAINTENANCE

• Replace RS199 Cleaning Sponge

1. Fill water only up to the top of the **RS243** Leveling Pad.
2. Depress **RS199** to moisten it completely.

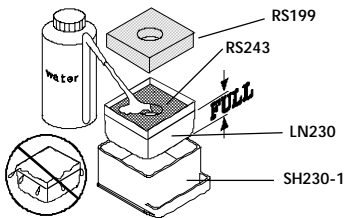

CAUTION:
Over-filling can cause thermal shock to the tip or heating element during tip cleaning.

• Replace SC581 Solder Collector

1. Hold the Housing firm and turn Cap counter-clockwise and pull it away from the Housing.
2. Remove used **SC581** and replace with a new one.
3. Reassemble Pod with TOP of the Cap in proper position.

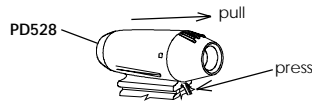

To replace Pod, press Release Tab and slide out Pod.

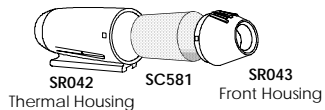

TEMPERATURE CALIBRATION

AIR MOVEMENT WILL AFFECT THE TEMPERATURE READING.

WORK IN AN AREA WHERE THIS IS MINIMUM.

1. Use the **DS299S** to remove the temperature control knob. Turn Temp. Control **(A)** so arrow points to cord.
2. Use the **SRW01** to pull out heater assembly, PCB & power cord from handle. Leave enough power cord slack to install **SRF30**.

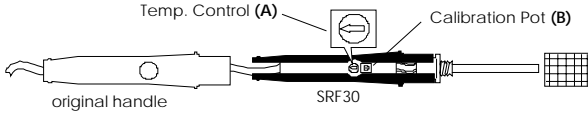

3. Place heater assembly, PCB & power cord inside **SRF30**. Install tip that is clean and well tinned.
4. With the use of the **MS412 Temperature Calibration System**. Follow set-up shown below.
5. Plug in tool and by using the Pot Adjustment Tool supplied, turn Temp. Control **(A)** to "solder-melt" temperature.
6. Apply a small amount of solder on the Tip, just enough to form a solder bead on top of the Tip. Place the center of the thermocouple wire of the on top of the solder bead.
7. Again, apply a small amount of solder on the center of the cross wire, just enough to embed the center.
8. Turn Temp. Control **(A)** fully clockwise. Adjust Calibration Pot **(B)** until reading stabilizes at 800°F.
9. Assemble unit in original handle.
10. Before installing the Temp. Control Knob, peel-off pointer label from the Knob.
11. Using same MS412 set-up, install and adjust Temp. Control Knob so Meter will read desired temperature.
12. Attach new pointer label in accordance with the reading of the Meter.

Tools Needed

- SRW01
- DS299S
- SRF30
- MS412
- Pot Adjustment Tool



POINTER LABEL

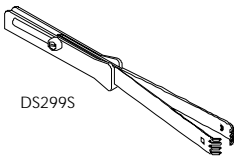

DS299S



SRW01

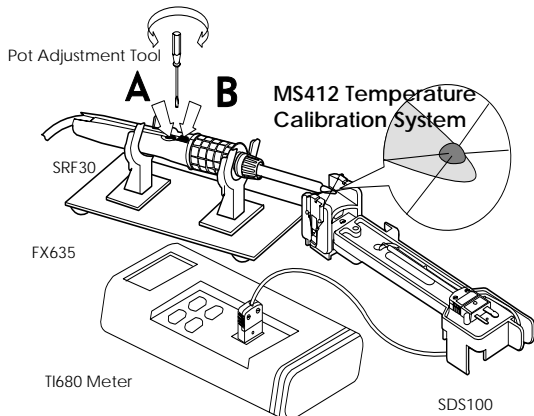

TIP CLEANING To maintain proper Tip to Ground resistance.

1. Remove Tip from Heater Assembly.
2. Using a **ST707 Soldering Tool Maintenance Brush**, clean Tip and Heater Barrel at surfaces shown.

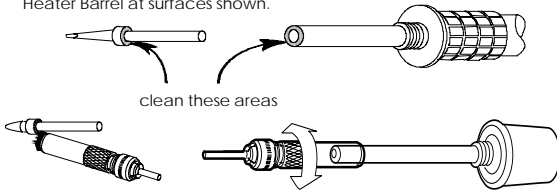

3. Install the tip and tighten RS372 Retaining Sleeve. Take note of the gap to ensure proper fitting.

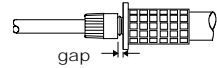

If there is no gap, try replacing the **RS372** Retaining Sleeve.

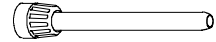

CL1080 LONER[®] Soldering Instrument Spare Parts List

Disassembly of this Tool will require the use of **SRW01** Heater Removal Tool.

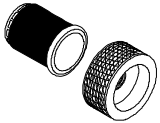

ITEM NO.	PART NO.	DESCRIPTION	QTY
1	LT375	LONER [®] Standard Spade Soldering Tip	1
2	RS372	Retaining Sleeve Assembly (RS382 & RB386)	1
2a	RS382	Retaining Sleeve	1
2b	RB386	Retaining Bushing	1
3	SR070	120 V Hollow Heater Assembly	1
4	SR081	Vinyl Finger Grip for Retaining Collar.	1
5	RC334	Threaded Retaining Collar for Heater Assy.	1
6	SR028	Power Cord, 3-Prong, 120 VAC	1
7	SR029	Boot for Power Cord	1
8	SR030	Clear Handle for Model 930	1
9	SR031	Knob, Temperature Control for Clear Handle	1
10	SR111	Logo, Pointer, 3/8" Dia. Self Adhesive	1
11	SR032	Cord Strain Relief	1
12	SR033	Circuit Board, Model 930	1

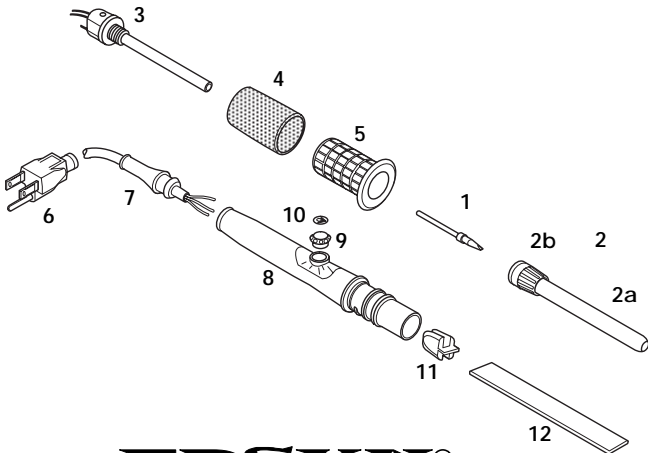

15958 ARMINTA ST. VAN NUYS, CA 91406-1896
 PHONE: 818.989.2324 FAX (sales): 818.997.0895
 Email: info@edsyn.com Internet: www.edsyn.com